



Modeling a Non-Flooding Hybrid Polymer Electrolyte Fuel Cell and Related Diffusion-Migration-Reaction Systems

4 October 2012

Benjamin E. McNealy, Joshua L. Hertz

Center for Fuel Cell Research

Department of Mechanical Engineering

University of Delaware

Email: bmcnealy@udel.edu

Introduction

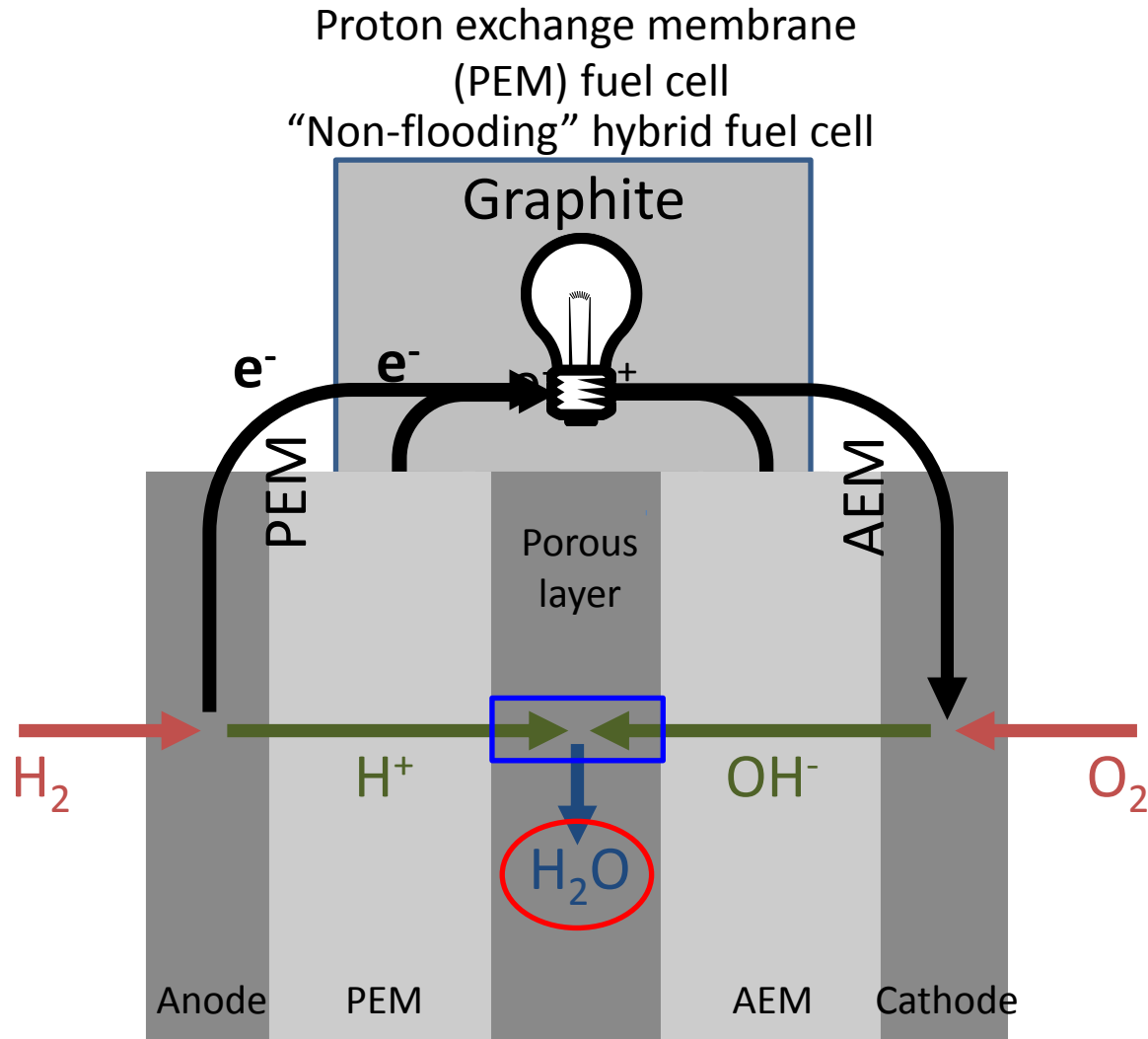

1D, time-dependent model in COMSOL 4.2a

- **Governing equations**
 - Transport of diluted species (Nernst-Planck)
 - Electrostatics (Poisson)
- **Boundary conditions**
 - Inward H^+ flux at $x = 0$
 - Inward OH^- flux at $x = L$
 - Zero flux of other species (H^+ , OH^- , e^- , hole $^+$)
 - Electrical ground at $x = 0$, zero charge at $x = L$
- **Initial conditions**
 - Ion concentrations based on neutral pH
 - Electron/hole concentrations from the literature (graphite)¹
 - Zero voltage

¹ J. W. McClure, *Phys. Rev.*, **112**, 715 (1958).

Goals

- Comparison with experimental results^{1,2}
 - Resistance vs. current
 - Insulating porous layer
- Temperature and thickness effects
- Examine other applications

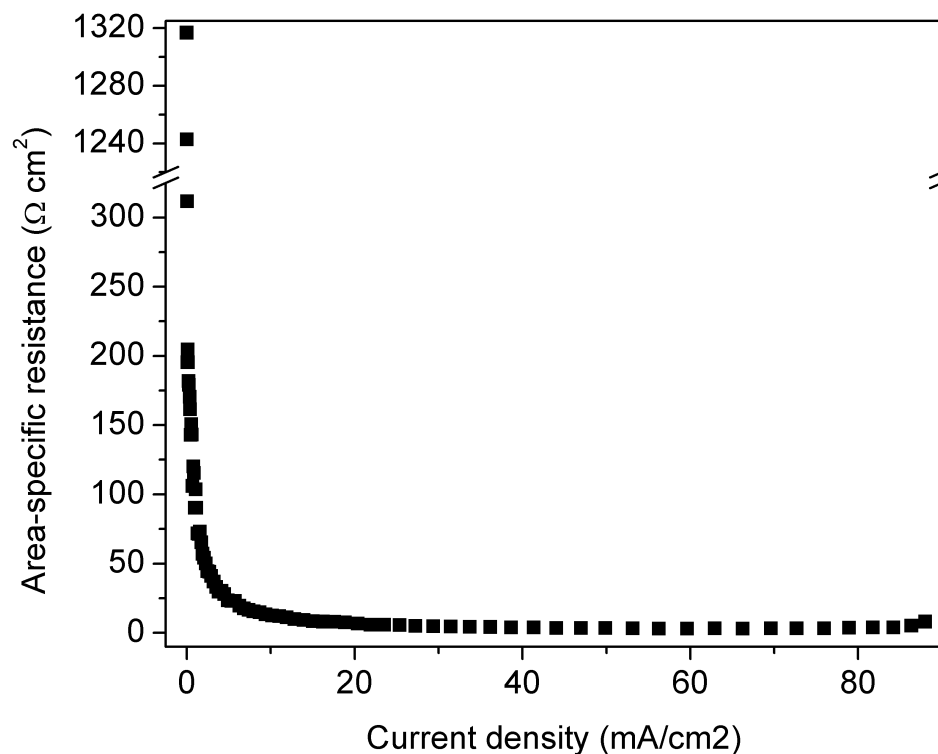

¹ W. Shen, F.-Y. Zhang, A. K. Prasad, and J. L. Hertz, *Electrochem. Soc. Trans.*, **33**, 2011 (2010).

² W. Shen, A. K. Prasad, and J. L. Hertz, *Electrochem. Solid-State Lett.*, **14**, B121 (2011).

Ion concentration and conductivity

Ion concentration profiles

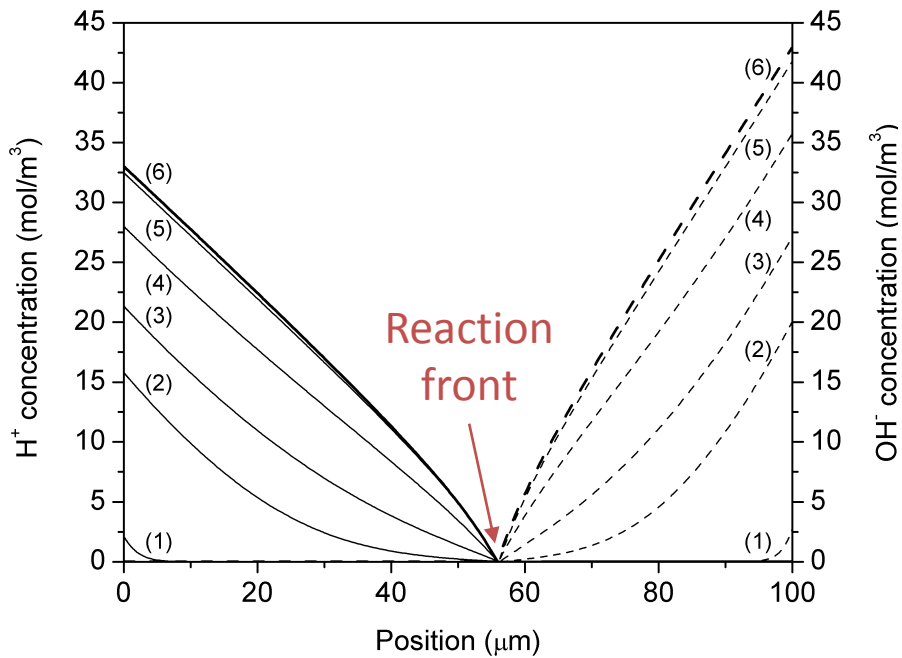

Conductivity

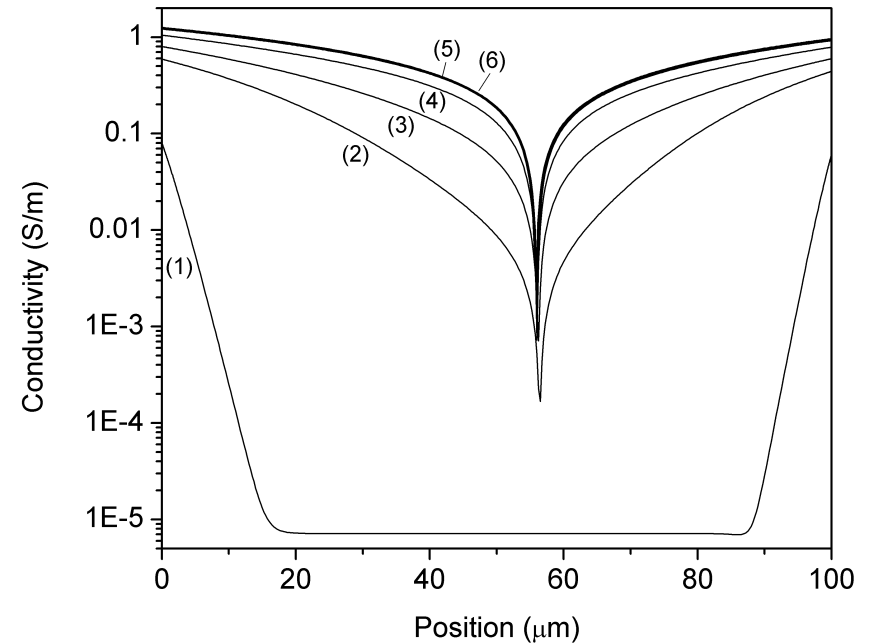

$$I = 100 \text{ mA/cm}^2$$

$t = (1) 0 \text{ s}, (2) 0.025 \text{ s}, (3) 0.05 \text{ s}, (4) 0.1 \text{ s}, (5) 0.2 \text{ s}, (6) 2 \text{ s (steady state)}$

Electron/hole effects

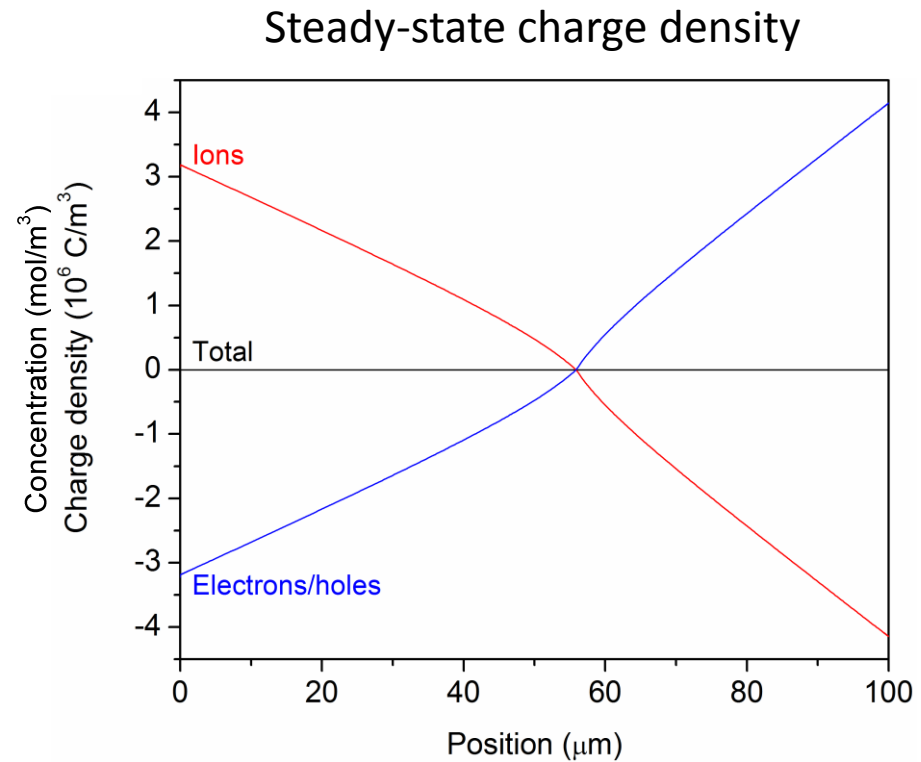
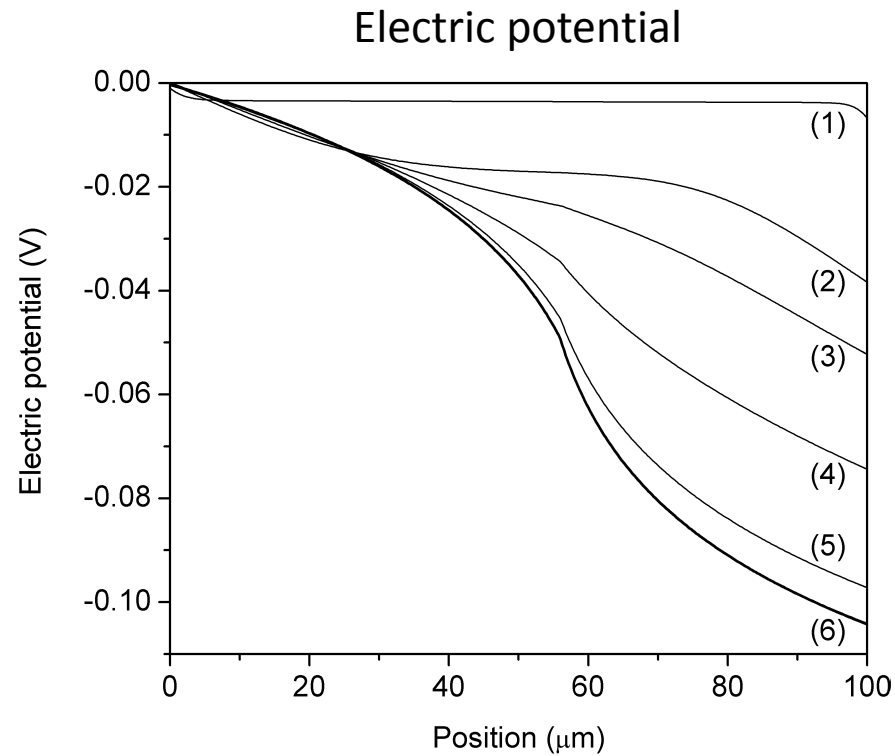

$$I = 100 \text{ mA/cm}^2$$

$t = (1) 0 \text{ s}, (2) 0.025 \text{ s}, (3) 0.05 \text{ s}, (4) 0.1 \text{ s}, (5) 0.2 \text{ s}, (6) 2 \text{ s (steady state)}$

Resistance

Resistance vs. current

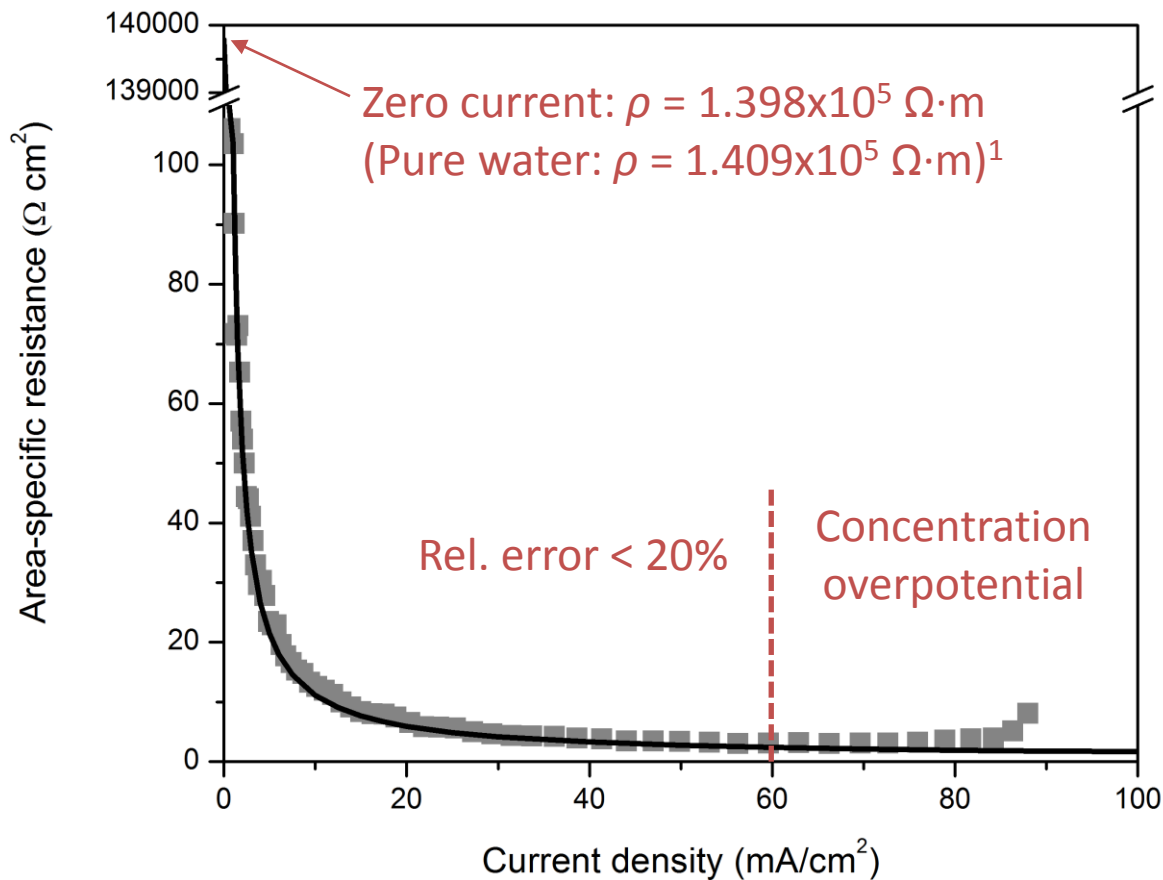

At $I = 60 \text{ mA/cm}^2$
 $r = 2.5 \Omega \text{ cm}^2$

For comparison:

Nafion ($50 \mu\text{m}$):
 $r \approx 0.05 \Omega \text{ cm}^2$

Fumapem FAA ($50 \mu\text{m}$):
 $r \approx 0.66 \Omega \text{ cm}^2$

¹ T. S. Light, S. Licht, A. C. Bevilacqua, and K. R. Morash, *Electrochem. Solid-State Lett.*, **8**, E16 (2005).

Thickness effects

Resistance vs. thickness

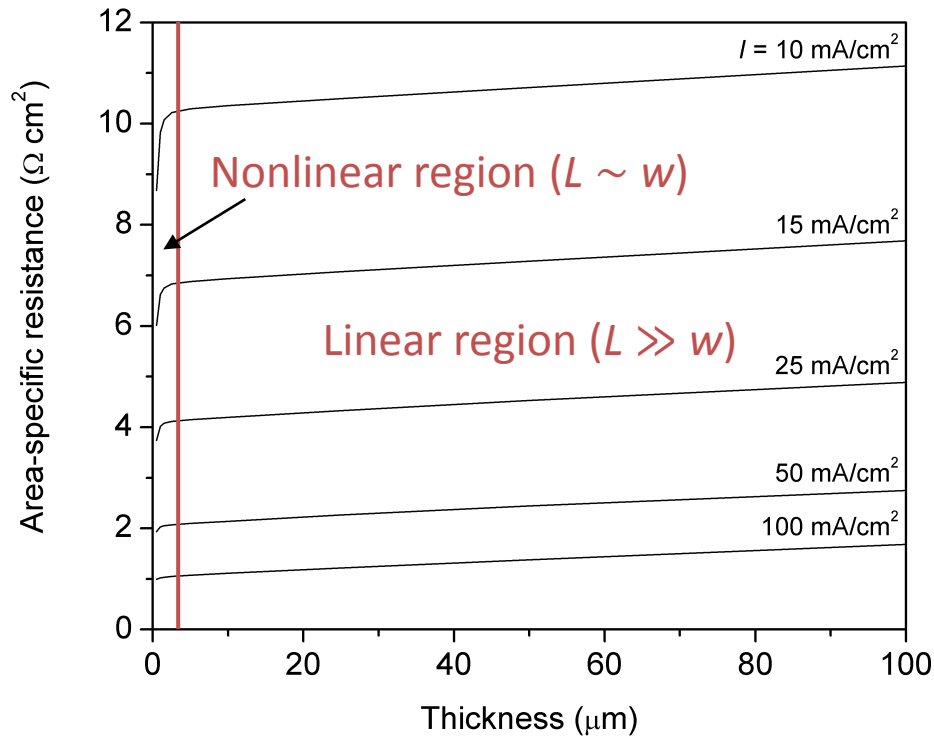

Local conductivity

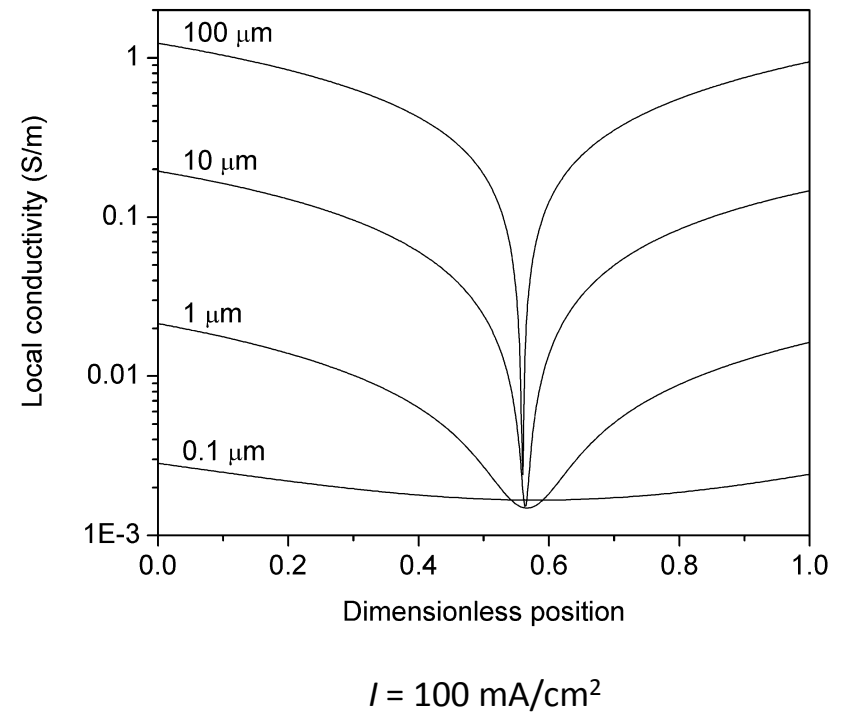

Temperature effects

Resistance

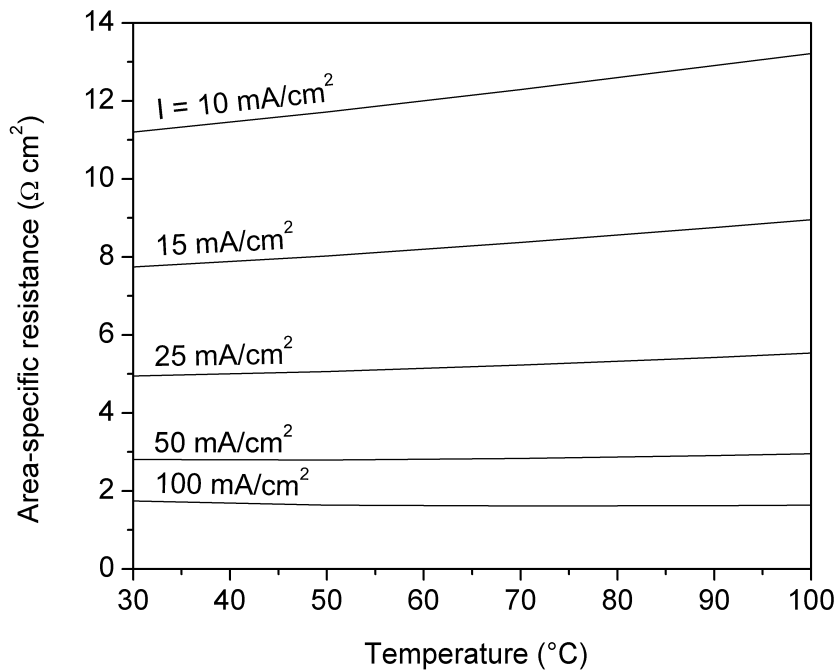

Ion density per area

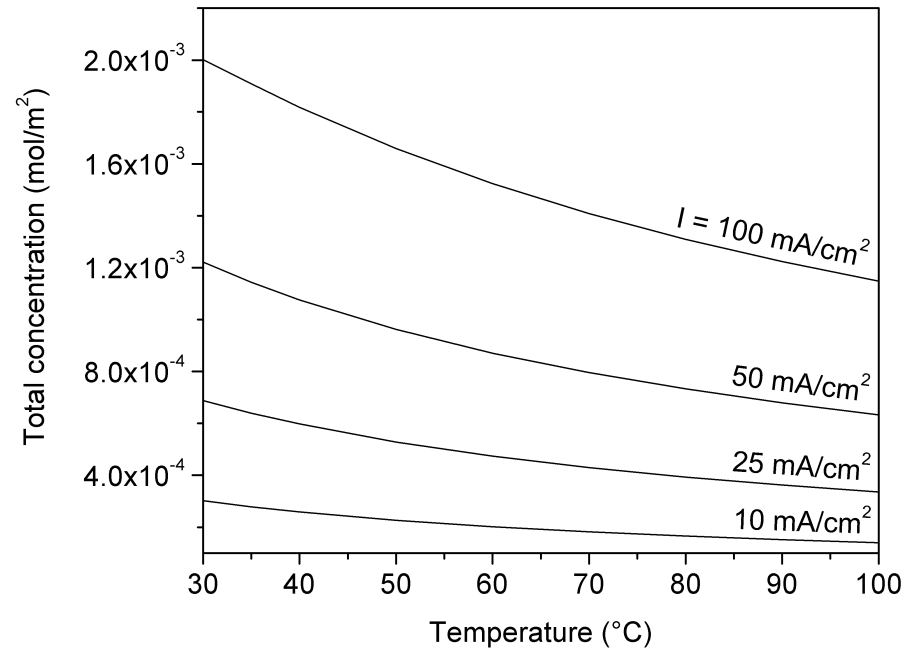

Related systems

- Model can be extended to more complex cases, e.g. interdiffusion of $\text{AgNO}_3/\text{NaCl}$ solutions
- Buildup of AgCl precipitate at the reaction front impedes diffusion
- Potential applicability to corrosion or biomineralization phenomena

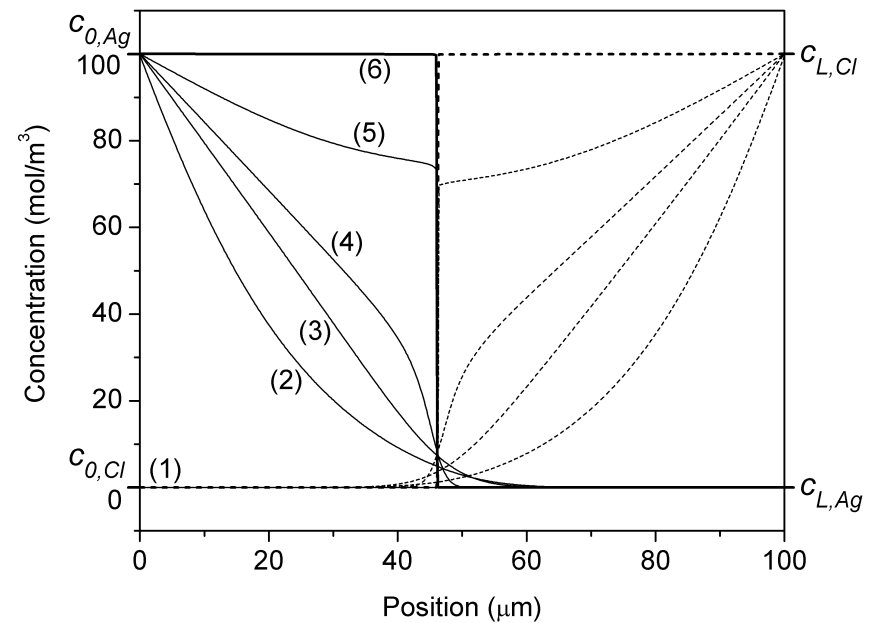

Concentration profiles for Ag^+ (solid line) and Cl^- ions (dashed line) at $t = (1) 0 \text{ s}, (2) 0.6 \text{ s}, (3) 5 \text{ s}, (4) 125 \text{ s}, (5) 127 \text{ s}, (6) 140 \text{ s}$.¹

¹ B. E. McNealy and J. L. Hertz, *submitted*.

Conclusions

- 1D porous layer model developed in COMSOL Multiphysics
- Unified treatment of heterogeneous electrochemical species in a Poisson-Nernst-Planck framework
- Good match with experimental results
 - Porous layer behaves as non-Ohmic electrolyte
 - Successful operation requires electron/hole conduction in porous layer scaffold
 - Porous layer dominates overall hybrid fuel cell resistance
- Resistance generally increases with thickness and temperature
- Model can be extended to have wider applicability