

Full Simulative Approach to OAM Transmissions between Antenna Arrays

A. Cagliero¹, A. De Vita², R. Gaffoglio^{1*} and B. Sacco²

¹ Department of Physics, University of Torino, Torino, Italy

² Centre for Research and Technological Innovation, RAI Radiotelevisione Italiana, Torino, Italy

* Corresponding author: rossella.gaffoglio@unito.it

Abstract: The possibility of exploiting the Orbital Angular Momentum (OAM) of light as a means to simultaneously transmit radio signals at the same frequency led us to the experimental implementation of an OAM-based multiplexing scheme between antenna arrays. Within this framework, the realization of a full-wave simulation of the communication link with COMSOL Multiphysics[®] proved essential both as a guide to the experimental setting and as a numerical validation of the achieved results.

Keywords: COMSOL Multiphysics; link budget; Orbital Angular Momentum (OAM); uniform circular arrays.

1. Introduction

In the recent years, electromagnetic waves carrying Orbital Angular Momentum (OAM) have attracted a widespread interest in the scientific community, with several applications ranging from information transfer to astronomical measures [1]-[3]. OAM beams are characterized by an on-axis intensity null and twisted wavefronts, whose azimuthal phase structure depends on the mode index ℓ related to the orbital angular momentum content [4]. In particular, the intrinsic orthogonality of such waves suggested the idea of exploiting their phase distribution for conveying multiple communication subchannels at the same frequency in the context of telecommunications [5], [6].

In this paper we introduce how the software COMSOL Multiphysics proved to be an essential tool for the implementation of an OAM-based multiplexing technique at the radio frequencies between antenna arrays. We reproduced the OAM beams in COMSOL through the simulation of properly phased Uniform Circular Arrays (UCAs) and we proved how, for a generic OAM communication link, a suitable combination of the simulative output data confirms the validity

of the theoretical reformulation of the link budget concept proposed in [7]. It was in light of this result that we experimentally implemented a multimode transmission of DVB-T signals at the same frequency between UCAs and we supported our investigations by reproducing the whole experimental scenario in COMSOL [8]. Therefore, COMSOL Multiphysics not only proved to be a very efficient tool for our preliminary analyses, but it allowed us to get reliable results in good agreement with the experiment.

2. OAM beams in COMSOL

2.1 Uniform Circular Arrays

One of the most commonly employed technique for generating OAM beams at the radio frequencies concerns the use of properly phased Uniform Circular Arrays (UCAs) [5]. A N -element UCA able to radiate an OAM beam with index ℓ consists of N antennas equally spaced around a circle, fed with signals having the same amplitude and a progressive phase shift of $2\pi\ell/N$. The left picture of Fig. 1 shows an UCA made of $N = 8$ Yagi-Uda antennas, realized with the software COMSOL Multiphysics. The considered Yagi-Uda antenna is composed by a single driven element and four parallel passive radiators; each metallic rod is not modeled as a cylinder

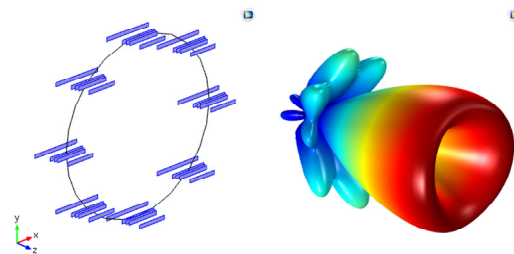

Figure 1. Uniform Circular Array made of $N = 8$ Yagi-Uda antennas (*left*) and the corresponding radiation pattern obtained with the software COMSOL Multiphysics for $\ell = \pm 1$ (*right*).

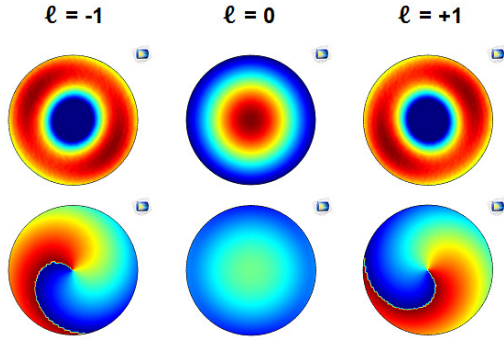

Figure 2. Intensity (*upper row*) and phase (*lower row*) profiles of the OAM modes with index $\ell = -1, 0, 1$ generated by the 8-element UCA of Yagi-Uda antennas reported in Fig. 1.

der, but rather as a two-dimensional strip with a Perfect Electric Conductor condition imposed on its surface, in order to speed up the mesh generation process without noticeable loss of accuracy. An OAM beam with azimuthal index ℓ can be generated by properly feeding the lumped ports inserted on the driven element of each antenna in such a way that the voltage supply relative to the n th radiator is given by:

$$V_n^\ell = V_0 \Phi_n^\ell \equiv V_0 \exp \left[i \ell 2\pi \left(\frac{n-1}{N} \right) \right], \quad (1)$$

being V_0 the constant voltage amplitude. The right picture of Fig. 1 shows the radiation pattern provided by COMSOL for an OAM beam with index $\ell = \pm 1$, generated by the considered 8-element UCA of Yagi-Uda antennas. It should be noted that the so-derived radiation pattern (i.e., the normalized gain) shows a null on the propagation axis, rather than the maximum usually exhibited by the conventional untwisted radiation. The intensity and phase profiles of OAM beams with index $\ell = -1, 0, 1$, displayed in the xy plane, are instead reported in Fig. 2. Such examples confirm the well known features of OAM beams with index $\ell \neq 0$, characterized by an azimuthal phase variation of $2\pi|\ell|$ around the central axis of zero intensity, with a handedness dictated by the sign of ℓ [4].

2.2 Link budget estimation

At the radio frequencies, the link budget estimate is fundamental to describe a communica-

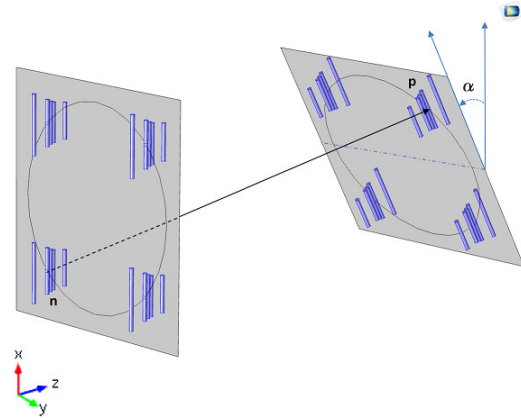

Figure 3. Two facing 4-elements UCAs of Yagi-Uda antennas designed with the software COMSOL Multiphysics.

tion link in terms of the ratio between the power intercepted by the receiver and that emitted by the transmitter. For conventional waves, this ratio can be obtained with the Friis equation [9] starting from the antenna gains, which exhibit a maximum along the propagating direction. Unfortunately, the above approach provides inconsistent results for an OAM transmission, since, in this case, the radiation pattern shows a null gain on the axis. The peculiar characteristics of twisted radiation suggest that an incoming OAM beam must be properly rephased at the receiver in order to ensure a non-null on-axis power transfer response. According to this consideration, an approximate link budget formula for OAM transmissions between UCAs was presented in [10]. Then, in [7], our research group has proposed a further generalization of this formula, defining a new kind of diagram, called ‘‘OAM-link pattern’’, which provides the link budget for an OAM communication link as a function of the rotation angle of the transmitting or the receiving systems and presents an on-axis power maximum in correspondence of the conventional radiation pattern null.

Within this context, in order to numerically confirm the validity of our formulation, we reproduced in COMSOL Multiphysics an OAM transmission between a couple of facing UCAs, like those depicted in Fig. 3. As described in detail in the following section, such simulation can be carried out by means of two different approaches, both enabling a link budget estimation through the following expression:

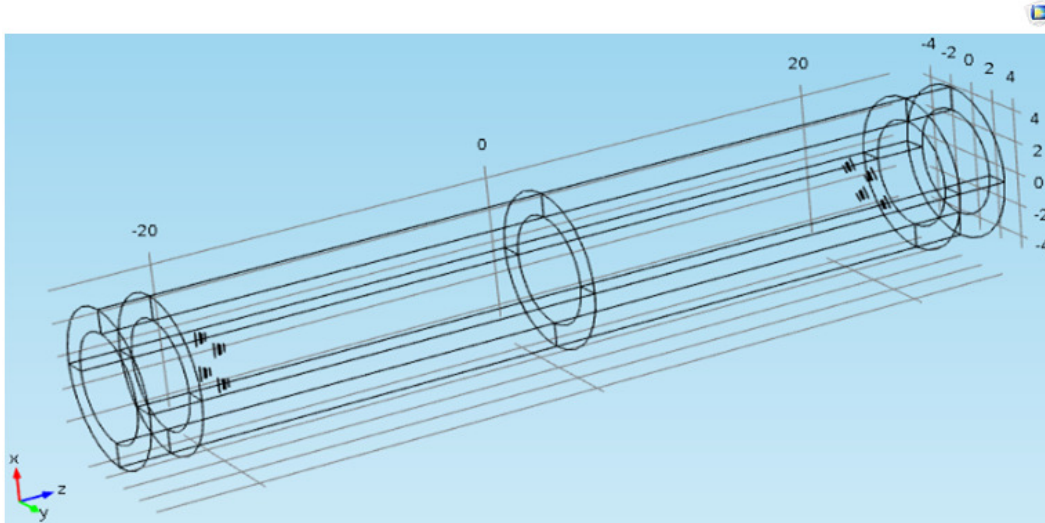

Figure 4. The COMSOL geometry for the simulation of the whole transmission link.

$$\frac{P_{out}}{P_{in}} = \frac{\left| \frac{1}{\sqrt{N}} \sum_{p=1}^N \Phi_p^{-\ell} V_{port}^p \right|^2}{\sum_{n=1}^N |V_n^\ell|^2}, \quad (2)$$

where V_n^ℓ is the input voltage (1) to the n th transmitting radiator, V_{port}^p is the voltage induced on the p th receiving port, available in post-processing, while $\Phi_p^{-\ell}$ is the phase-weighting introduced at the p th receiving element and defined according to (1).

3. Methods

The proposed set-up, which has been considered in both the numerical studies and the experiment, consists in a 40 m-length free space RF link at 198.5 MHz. As transmitting and receiving structures, two UCAs composed by four Yagi-Uda antennas have been employed. The main goal of our preliminary investigations was to provide a characterization of the link in the presence of an OAM beamforming, through the estimation of the link budget as a function of the receiving array rotation angle. Such characterization has been performed numerically in COMSOL Multiphysics, making it possible to implement the experimental analysis described in the next section and to validate the corresponding results.

3.1 First simulative approach

The first strategy which has been carried out in our numerical study consisted in implementing the whole simulation of the communication link in a unique model. Being the size of the system considerable, a cylindrical transmission volume was chosen in order to optimize the memory requirements for the given geometry (Fig. 4). A Perfectly Matched Layer (PML) was introduced around the cylinder in order to absorb all the outgoing waves. The transmitting and receiving antennas were designed entirely within the COMSOL model builder. The antennas length was fixed via the optimization module by requiring a minimum S_{11} parameter for each lumped port. Both the link distance d and the receiving array rotation angle α were parameterized, enabling the use of parametric sweeps which proved fundamental for the model analysis.

In order to generate a beam with azimuthal index ℓ , the four ports of the transmitting UCA were fed according to expression (1). For simplicity, the phasing of each transmitting antenna has been directly provided through the lumped ports excitation, without simulating the electronic beamforming network. Then, according to (2), the link budget for the corresponding OAM transmission was derived from the computed port voltages relative to the receiving UCA.

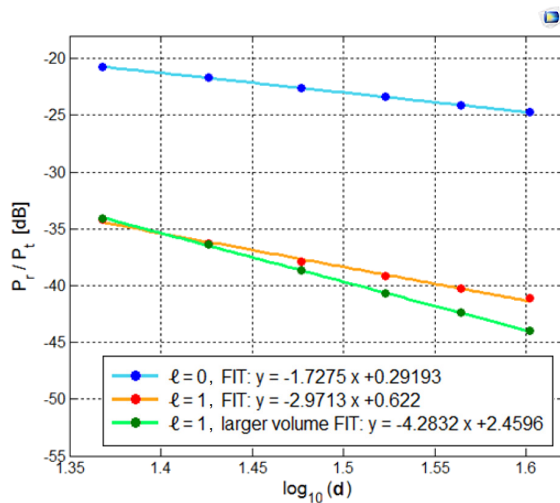

Figure 5. Link budget as a function of the link distance d for three different configurations, evaluated using the first simulative approach.

Although the presented approach seems to offer a valid method for our case, since it takes into account the whole space involved in the electromagnetic transmission, it is not without drawbacks. Problems arise for large link distances, especially in this scenario where OAM propagation is considered. Indeed, for $\ell \neq 0$, the beam divergence angle is bigger than in the $\ell = 0$ case and the only way to avoid possible reflections from the PML walls at great d is to increase the diameter of the cylindrical transmission volume. To confirm this, in Fig. 5 the link budget as a function of the antenna array separation d is reported for three different configurations, showing a deviation from the expected OAM beams power decay $d^{-2\ell-2}$ in correspondence with a not enough large transmission volume, for $\ell = 1$.

Unfortunately, the meshing of a cylinder more than 20 m in length and with a diameter sufficient to avoid most of the reflections on the PML walls would have required an excessive computational capacity to be tolerated by our server machine. Hence, the described simulative approach turned out to be sufficient for our preliminary analyses, but unable to describe a 40 m OAM transmission, which is the distance covered in the experimental stage. Therefore, with the proposed strategy, we had to take into account extrapolation techniques for providing a reliable numerical estimate at great distances. On the other hand, COMSOL offers alternative solutions that can be easily implemented in this case.

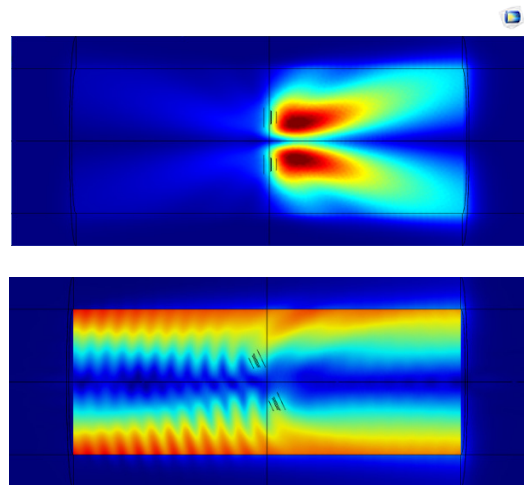

Figure 6. Electric field norm for the transmission (*up*) and the reception (*down*) of an OAM wave in two separated COMSOL simulations.

3.2 Second simulative approach

When simulating a far-field RF link with COMSOL Multiphysics, the transmission and the reception stages can be treated separately (see Fig. 6). In particular, it is possible to solve for the transmission and compute the corresponding far-field, which is directly accessible in post-processing; then, the stored information can be used as a boundary condition for the subsequent study, where the reception is implemented. The advantage of such a procedure lies in the fact that it is no longer necessary to account for the whole propagation volume, thus implying significant reductions in mesh and computational demand.

By considering this alternative approach, we were able to provide the sought-for estimation of the link budget for a 40 m-length transmission link.

As a first step, we placed the transmitting UCA in a much smaller dedicated volume, we fed it according to the chosen OAM configuration and we computed the corresponding far-field. In order to limit our analysis to the region of interest, we performed a Taylor expansion of the far-field in the neighbourhood of the receiving UCA position, which is located 40 m away from the transmitter, and we stored the relative coefficients.

In a second stage, the reception was implemented: by considering a volume with the receiving UCA only, we solved this specific model for the scattered field using the far-field expansion.

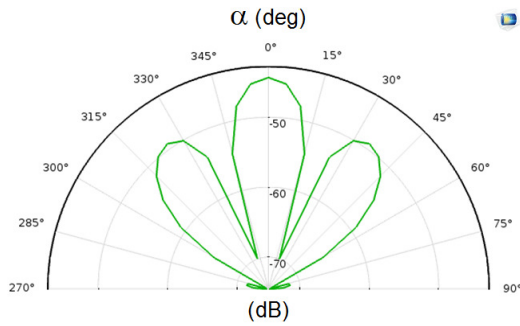

Figure 7. OAM-link pattern obtained with COMSOL for an OAM beam with index $\ell = 1$ as a function of the RX array rotation angle α .

sion derived in the previous stage as a background wave. A parametric sweep over the receiving UCA rotation angle was then realized, enabling the angular estimation of the link budget (Fig. 7), which was derived according to (2). Thanks to this second simulative approach it was possible to conclude our link budget estimation for a link distance of 40 m without needing any further extrapolation.

4. Experiment

Within the above described experimental setup, a simultaneous transmission of two digital television signals encoded as OAM modes has been carried out [8]. The two 3.1 m diameter UCAs were built connecting four folded Yagi-Uda antennas (Fracarro BLV4F) through a plastic PVC structure. The transmitting array was placed on a tripod and the receiving one was mounted on a rotary head with a 360° goniometer. By means of a specially devised synthesis method, two electronic networks called *OAM mode sorters* were properly designed for the arrays beamforming [11]. Although with 4 antennas all the modes with $|\ell| \leq 1$ could be implemented, we chose to limit our investigation to just the $\ell = \pm 1$ modes, for technical simplicity.

As a preparatory stage, the link was tested with the transmission and reception of both standard ($\ell = 0$) and OAM radiation ($\ell = 1$); in the latter case, particular attention was devoted to ensure a good alignment between the two UCAs, exploiting the characteristic topology of the OAM beams profile. In the $\ell = 1$ case the far-field OAM communication link was studied at various frequencies in the range 150÷300 MHz

and the corresponding link budget was analyzed by means of the angular scan generated by the rotation of the receiving system. All the measures were carried out by means of a Vector Network Analyzer (Anritsu MS2026C).

After the link setting and the measurement stage, two different high-definition TV streams (15.8 Mbit/s each) were played out simultaneously and modulated by two DVB-T modulators operating on nominal 198.5 MHz with 7 MHz channel bandwidth. The outgoing DVB-T signals, obtained with a 16-QAM modulation scheme with code rate 3/4, were then conveyed to the input ports of the transmitting mode sorter, whose outputs are connected to the Yagi-Uda antennas of the transmitting circular array. In this way, the two digital television signals have been encoded as OAM modes with indices $\ell = 1$ and $\ell = -1$ and simultaneously transmitted in the far-field region. Both signals reached the second UCA after a 40-m free space propagation. At the receiving side, the second mode sorter provided the separation of the $\ell = 1$ and $\ell = -1$ components, which were delivered to two TV receivers enabling the access to both the digital contents on two separate screens (see Fig. 8).

The reported real outdoor experiment represents, to the best of our knowledge, the first case of OAM multiplexing and de-multiplexing of DVB-T signals using two arrays of identical radiators in a far-field link. The TV signals reception was, on average, good, although the insulation between the two OAM channels fluctuated roughly between 11.2 dB (bad aiming) and 15 dB (good aiming) due to the wind. In fact, because of the strong sensitivity to misalignments, a coding/decoding system based on the OAM needs a good and constant antenna pointing. However, the performance might be improved with the introduction of a dedicated post-processing cancellation technique or by switching to a modulation scheme with a lower bitrate (e.g. the 16-QAM 2/3 modulation).

5. Results and comparison

In order to test the robustness of the considered communication link, we experimentally determined the link budgets relative to the transmission and the proper rephased reception of OAM modes with indices $\ell = 1$ and $\ell = 0$ (untwisted case), in correspondence of an optimal

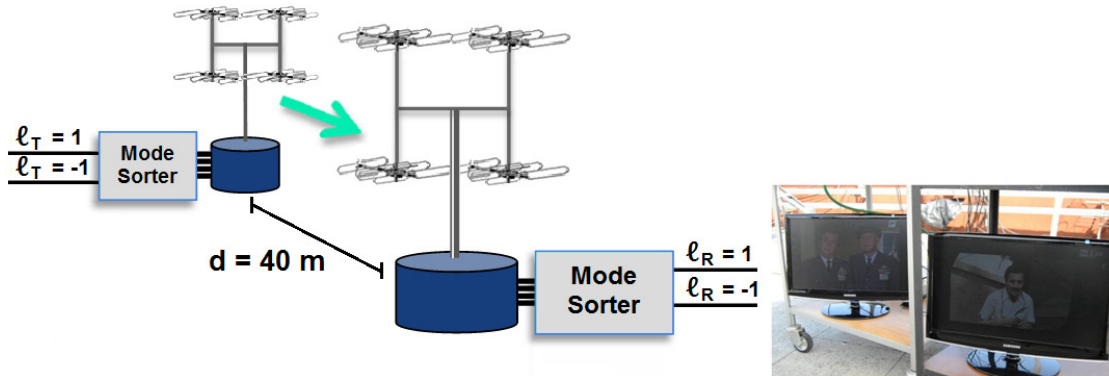

Figure 8. Schematic diagram of the OAM transmission experiment.

antenna pointing. Such estimations are also obtained numerically by means of expression (2), within the COMSOL model aimed at reproducing the experiment using the second simulative approach. As shown in Table 1, the COMSOL model predictions fit very well the experimental results, with a percentage error lower than 0.7% for the $\ell = 1$ transmission. Moreover, it should be noted that in the $\ell = 0$ case the reliability of the achieved results is further verified via the Friis equation.

Finally, it is important to emphasize that the polar plot of the link budget performed with COMSOL for the $\ell = 1$ mode and reported in Fig. 7 confirms our theoretical predictions [7], showing the expected on-axis power maximum when the proper mode-matching between the facing UCAs is considered.

6. Conclusions

In this work, the outcomes of a deep experimental investigation involving OAM transmissions between UCAs of properly phased Yagi-Uda antennas has been presented. In this sce-

nario we have shown how the software COMSOL Multiphysics proved to be a very efficient tool for our preliminary analyses, allowing us to get reliable results in good agreement with the experiment. The numerical study with COMSOL Multiphysics has been addressed by means of two different approaches: a full simulation, which is more indicated for near-field transmissions, requiring a higher computational cost, and a separate study, which is faster and better suited for far-field transmissions. The good agreement between the simulation outcomes and the experimental measures shows that the approximation introduced with the second method does not impair the required accuracy.

7. References

- [1] G. Gibson *et al.*, “Free-space information transfer using light beams carrying orbital angular momentum”, *Optics Express* **12**, 5448-5456 (2004).
- [2] A. Mair *et al.*, “Entanglement of the orbital angular momentum states of photons”, *Nature* **412**, 313-316 (2001).
- [3] M. Harwit, “Photon Orbital Angular Momentum in Astrophysics”, *The Astrophysical Journal* **597**, 1266-1270 (2003).
- [4] M. Padgett and L. Allen, “Light with a twist in its tail”, *Contemporary Physics* **41**, 275-285 (2000).
- [5] B. Thidé *et al.*, “Utilization of Photon Orbital Angular Momentum in the Low-Frequency Radio Domain”, *Physical Review Letters* **99**, 087701 (2007).
- [6] F. Tamburini *et al.*, “Encoding many channels on the same frequency through radio vortic-

Table 1: Link budget comparison in correspondence of an optimal antenna pointing.

Link Budget (dB)	$\ell = 0$	$\ell = 1$
Friis equation	-24.40	-
COMSOL simulation	-24.69	-42.96
Experiment	-25.50	-42.99

ity: first experimental test”, *New Journal of Physics* **14**, 033001 (2012).

[7] A. Cagliero *et al.*, “A New Approach to the Link Budget Concept for an OAM Communication Link”, *IEEE Antennas and Wireless Propagation Letters* **15**, 568-571 (2016).

[8] R. Gaffoglio *et al.*, “OAM multiple transmission using uniform circular arrays: numerical modeling and experimental verification with two digital television signals”, *Radio Science* **51**, 645-658 (2016).

[9] S. J. Orfanidis, *Electromagnetic Waves and Antennas*, (2014) [Online]. Available: <http://www.ece.rutgers.edu/~orfanidi/ewa>

[10] D. K. Nguyen *et al.*, “Discussion about the link budget for electromagnetic wave with orbital angular momentum”, in *EuCAP 2014 - The 8th European Conference on Antennas and Propagation* (2014).

[11] B. Sacco and A. De Vita, Patent WO/2015/159264 (2015).

8. Acknowledgments

We would like to thank the whole COMSOL technical support staff in Brescia for their availability and help, with particular regard to Cesare Tozzo and Gabriele Rosati for all the fruitful discussions.